

PARTS LIST

NRD-19RLW

510320 (D08W00)

510330 (D08W50) (NPT)

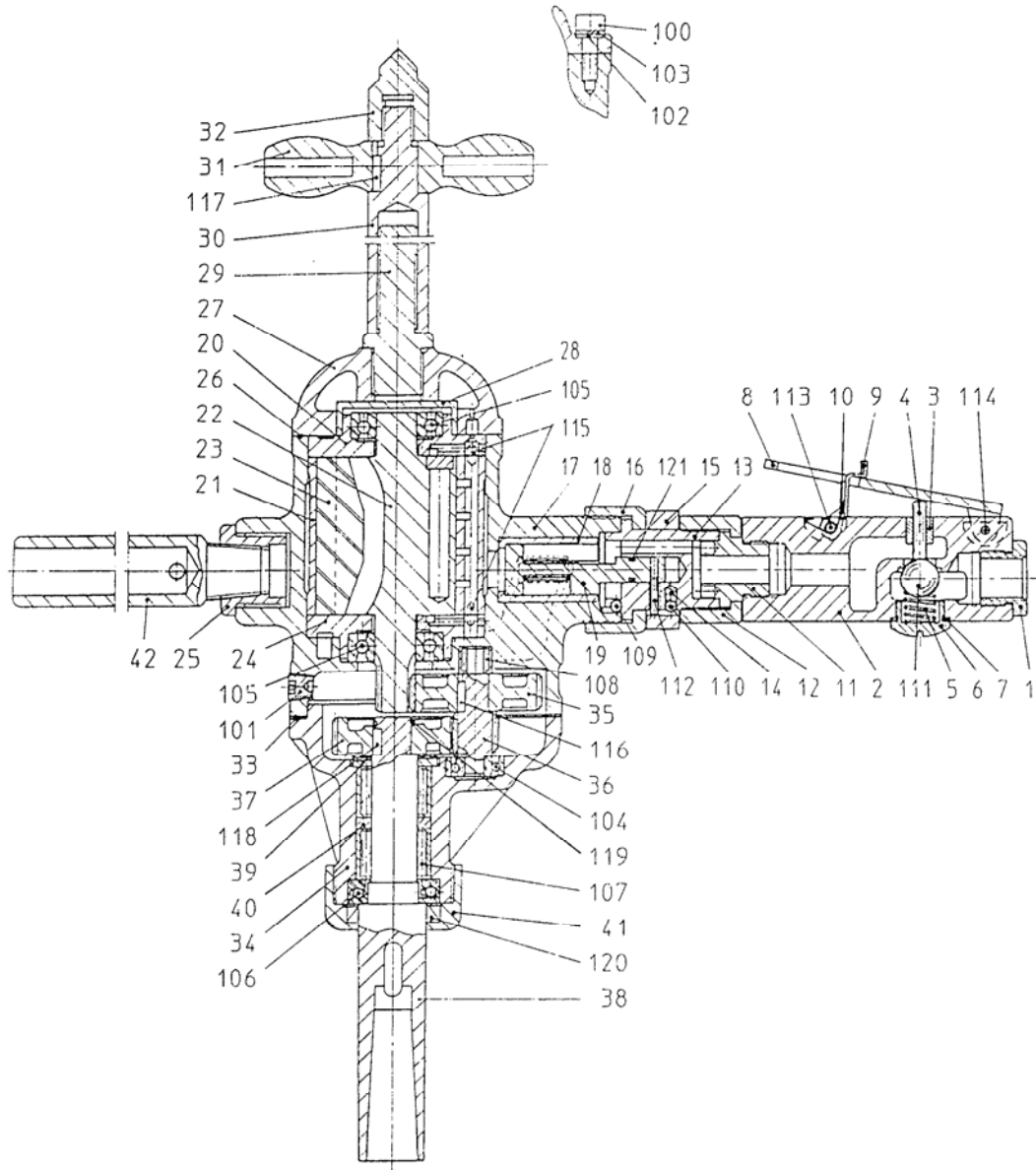

日本ニューマチック工業株式会社
NIPPON PNEUMATIC MFG.CO.,LTD.

新旧対照リスト

(1/2)

COMPARISON LIST

型式 MODEL: **NRD-19RLW**

新 NEW:510320

符号 ITEM	新品番 NEW PART NO.	現状品番 CURRENT PART NO.	品名 NEW PART NAME	CURRENT PART NAME	個数 Q'ty
1	15210840	I70010H020	INLET BUSHING	INLET BUSH	1
2	15008240	G53W10H290	THROTTLE ARBOR	THROTTLE ARBOR	1
3	15009270	G61000H270	THROTTLE BUSH	THROTTLE BUSH	1
4	15009280	G61000H310	THROTTLE PIN	THROTTLE PIN	1
5	15009260	G61000B210	THROTTLE SPRING	THROTTLE SPRING	1
6	15009290	G61000H360	THROTTLE PLUG	THROTTLE PLUG	1
7	15009340	G61000P800	RUBBER PACKING	RUBBER PACKING	1
8	15008260	G53W10H880	LEVER	LEVER	1
9	15008270	G53W10Z260	STOPPER	STOPPER	1
10	15008230	G53W10B250	STOPPER SPRING	STOPPER SPRING	1
11	15101330	D09W00H350	THROTTLE ADAPTOR	THROTTLE ADAPTOR	1
12	15101340	D09W00H390	ARBOR NUT	THROTTLE ARBOR NUT	1
13	15101320	D09W00H290	THROTTLE ARBOR	THROTTLE ARBOR	1
14	15007650	G53010B240	STOPPER SPRING	STOPPER BALL SPRING	1
15	15403740	L428000030	REVERSE LEVER	REVERSE LEVER	1
16	15101010	D09000H390	ARBOR NUT	THROTTLE ARBOR NUT	1
17	15101190	D09000R730	ROTOR CASE	ROTOR CASE	1
18	15101080	D09000H810	REVERSE BUSH	REVERSE BUSH	1
19	15101070	D09000H800	REVERSE VALVE	REVERSE VALVE	1
20	15101150	D09000R300	TOP PLATE	TOP PLATE	1
21	15101140	D09000R200	CYLINDER	CYLINDER	1
22	15101180	D09000R720	ROTOR	ROTOR	1
23	15101160	D09000R500	VANE	VANE	5
24	15101170	D09000R510	BOTTOM PLATE	BOTTOM PLATE	1
25	15207510	I45000Z370	SOCKET	SOCKET	1
26	15101120	D09000P300	TOP SEAL	TOP SEAL	1
27	15100950	D09000H060	OIL CASE	OIL CASE	1
28	15100960	D09000H070	OIL BUSH	OIL CASE BUSH	1
29	15101050	D09000H610	FEED SCREW	FEED SCREW	1
30	15101060	D09000H620	FEED SLEEVE	FEED SLEEVE	1
31	15101040	D09000H600	FEED HANDLE	FEED HANDLE	1
32	15101020	D09000H400	CENTER	CENTER	1
33	15101130	D09000P500	BOTTOM SEAL	BOTTOM SEAL	1
34	15101220	D09000S110	GEAR CASE	GEAR CASE	1
35	15101200	D09000S040	REDUCTION GEAR	L REDUCTION GEAR	1
36	15100910	D08000S050	REDUCTION GEAR	S REDUCTION GEAR	1
37	15100920	D08000S330	SOCKET GEAR	SOCKET GEAR	1

日本ニューマチック工業株式会社

NIPPON PNEUMATIC MFG. CO., LTD. NRD-19RLW_510320_D08W00_020416.xls

新旧対照リスト

(2/2)

COMPARISON LIST

型式 MODEL: **NRD-19RLW**

新 NEW:510320

符号 ITEM	新品番 NEW PART NO.	現状品番 CURRENT PART NO.	品名 NEW PART NAME	CURRENT PART NAME	個数 Q' ty
38	15101260	D09000S480	DRILL SOCKET	DRILL SOCKET	1
39	15101100	D09000I210	THRUST WASHER	THRUST WASHER	1
40	15101300	D09000Z780	BEARING COLLAR	BEARING COLLAR	1
41	15101240	D09000S340	SOCKET NUT	SOCKET NUT	1
42	15101110	D09000I580	HOLDER	HOLDER	1
43	18400540	0510000141	NANE PLATE	NANE PLATE	1
100	74006020	1050106020	CAP SCREW	HEX. SOCKET CAP SCREW	8
101	28100501	1700111007	HEX. SOCKET PLUG	HEX. SOCKET PLUG	2
102	76310206	1951010060	WASHER	PLAIN WASHER	8
103	76420106	1954020060	SPRING WASHER	SPRING WASHER	8
104	28201067	2012000608	BALL BEARING	BALL BEARING	1
105	28201089	2012006202	BALL BEARING	BALL BEARING	2
106	28202017	2180051104	THRUST BEARING	THRUST BEARING	1
107	28203052	2400182620	NEEDLE BEARING	NEEDLE BEARING	2
108	28203063	2460071712	NEEDLE BEARING	NEEDLE BEARING	1
109	25502120	2800110125	STEEL BALL	STEEL BALL	2
110	25502010	2800110150	STEEL BALL	STEEL BALL	1
111	28205053	2800210450	RUBBER BALL	RUBBER BALL	1
112	28206042	3010030210	PIN	PARALLEL PIN	1
113	28208061	3030030180	SPRING PIN	SPRING PIN	1
114	25305020	3030030250	SPRING PIN	SPRING PIN	1
115	25305050	3030040140	SPRING PIN	SPRING PIN	2
116	28209017	3102040410	KEY	KEY	1
117	28209020	3102040416	KEY	KEY	1
118	28209025	3102050510	KEY	KEY	1
119	25307280	3200010140	RETAINING RING	RETAINING RING	1
120	28302012	4011253805	OIL SEAL	OIL SEAL	1
121	61200060	4150100060	O RING	O RING	1
122	28210005	3352013032	DRIVE SCREW	DRIVE SCREW	4

日本ニューマチック工業株式会社

NIPPON PNEUMATIC MFG. CO., LTD. NRD-19RLW_510320_D08W00_020416.xls